

Phönix

Dieter Michael Krone
August 2009

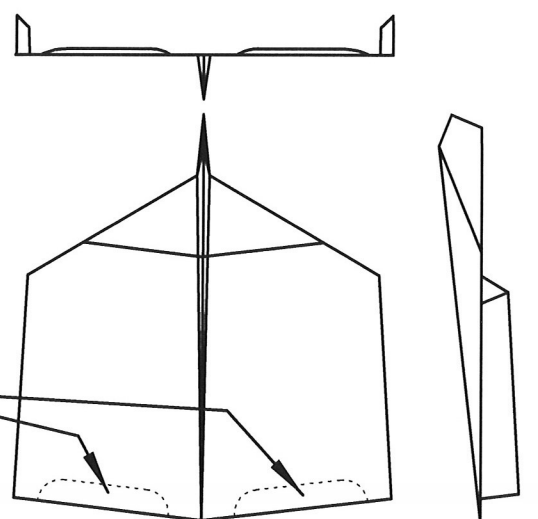

Zum Trimmen die Hinterkante der Flügel leicht nach oben wölben.

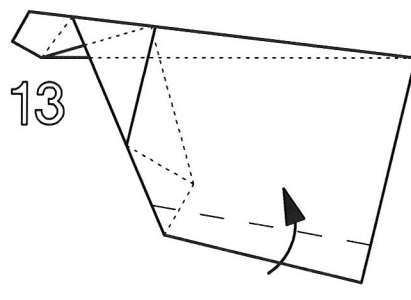
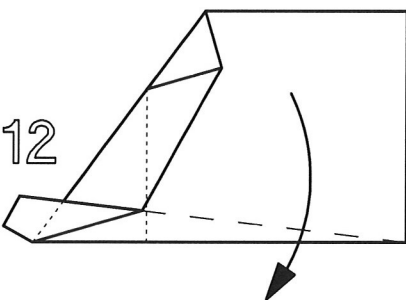
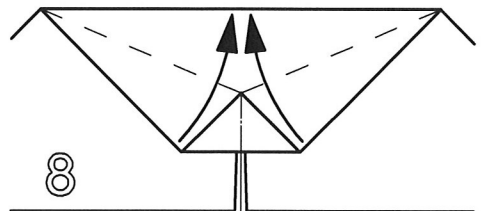
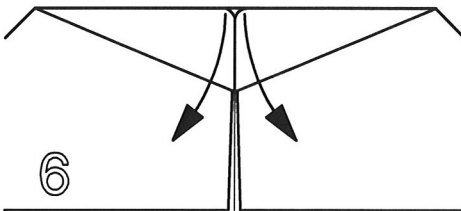
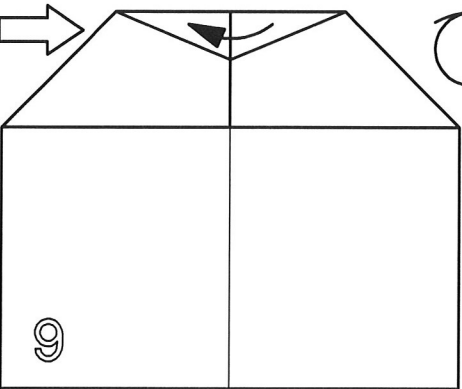
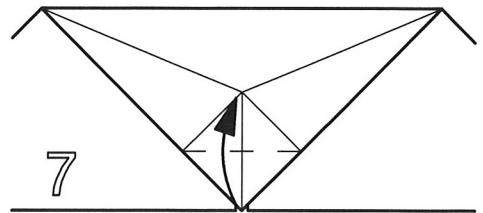
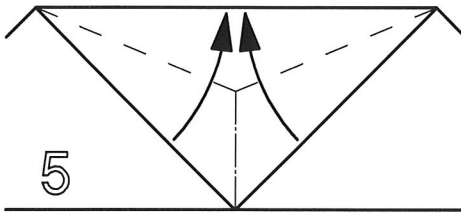
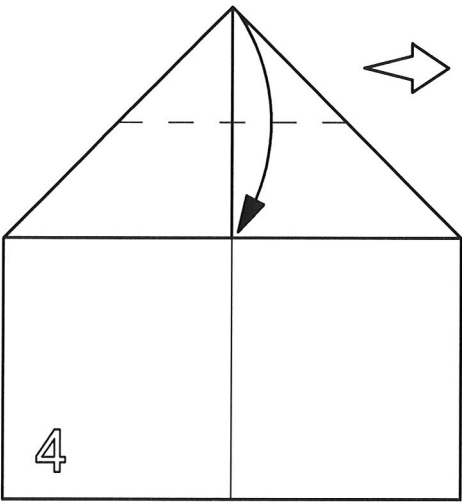
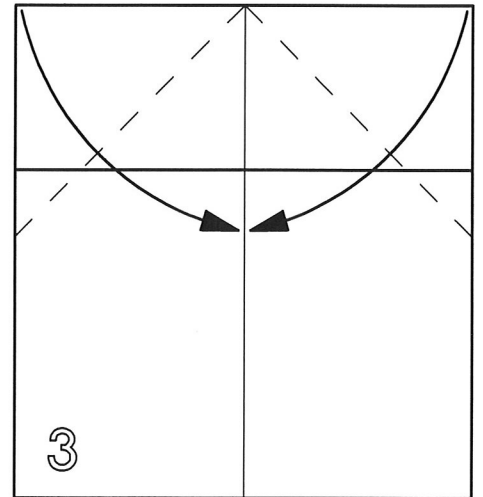
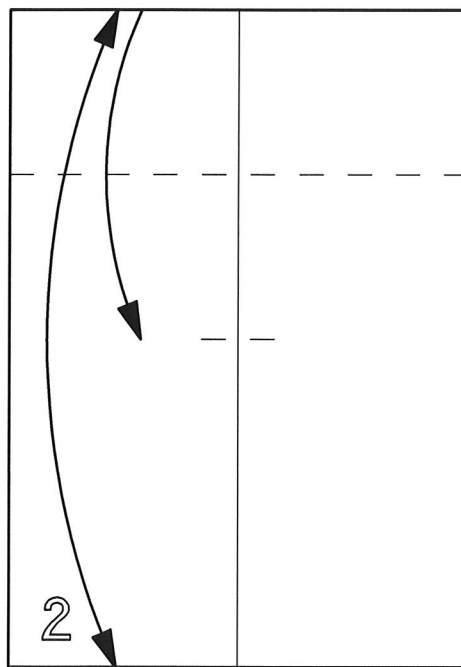
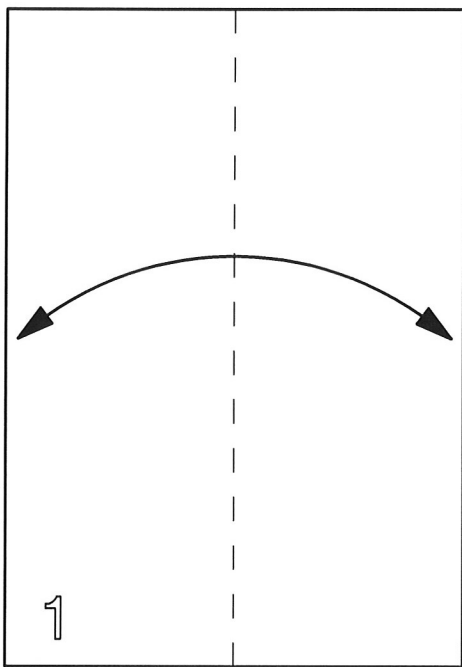
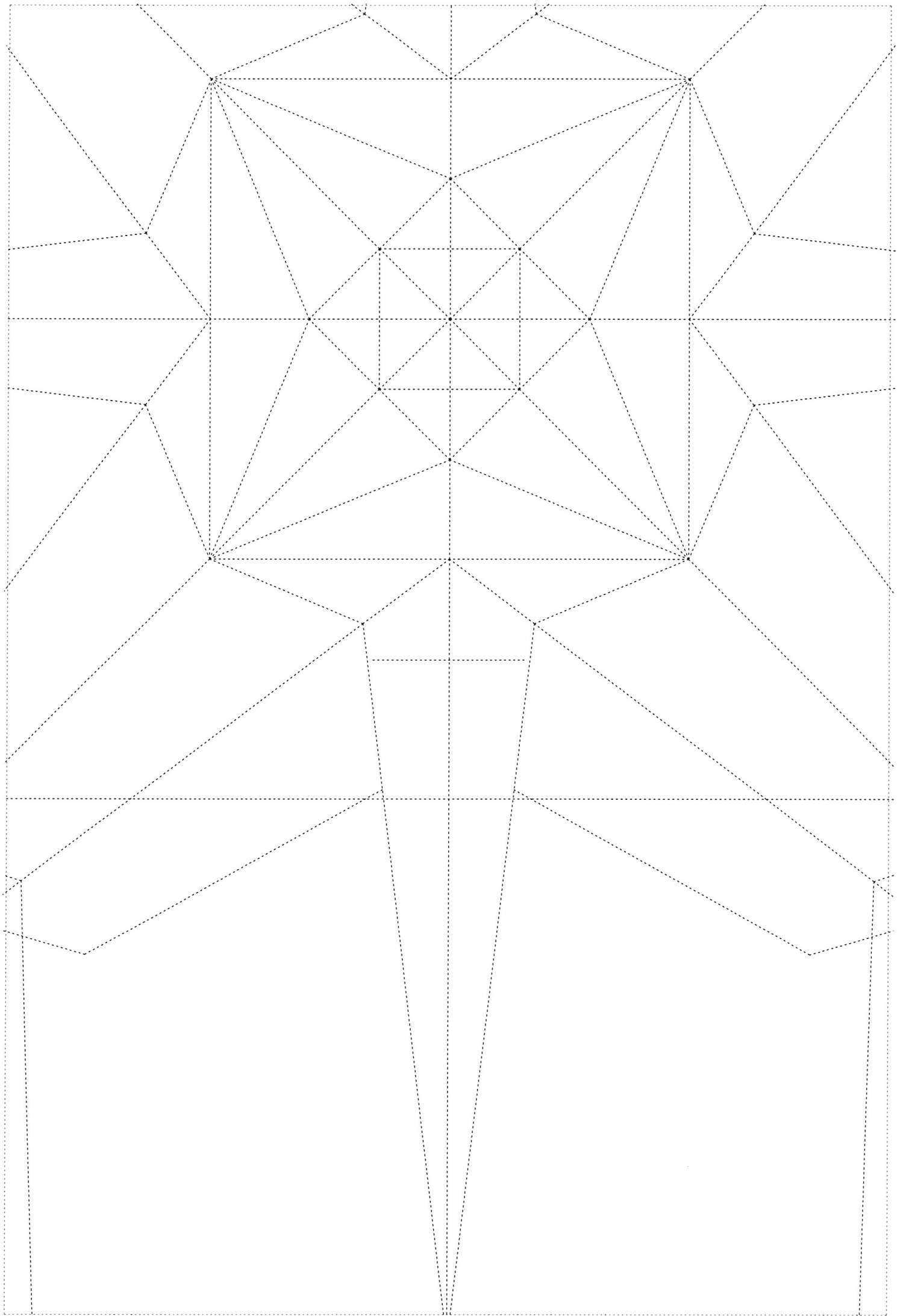



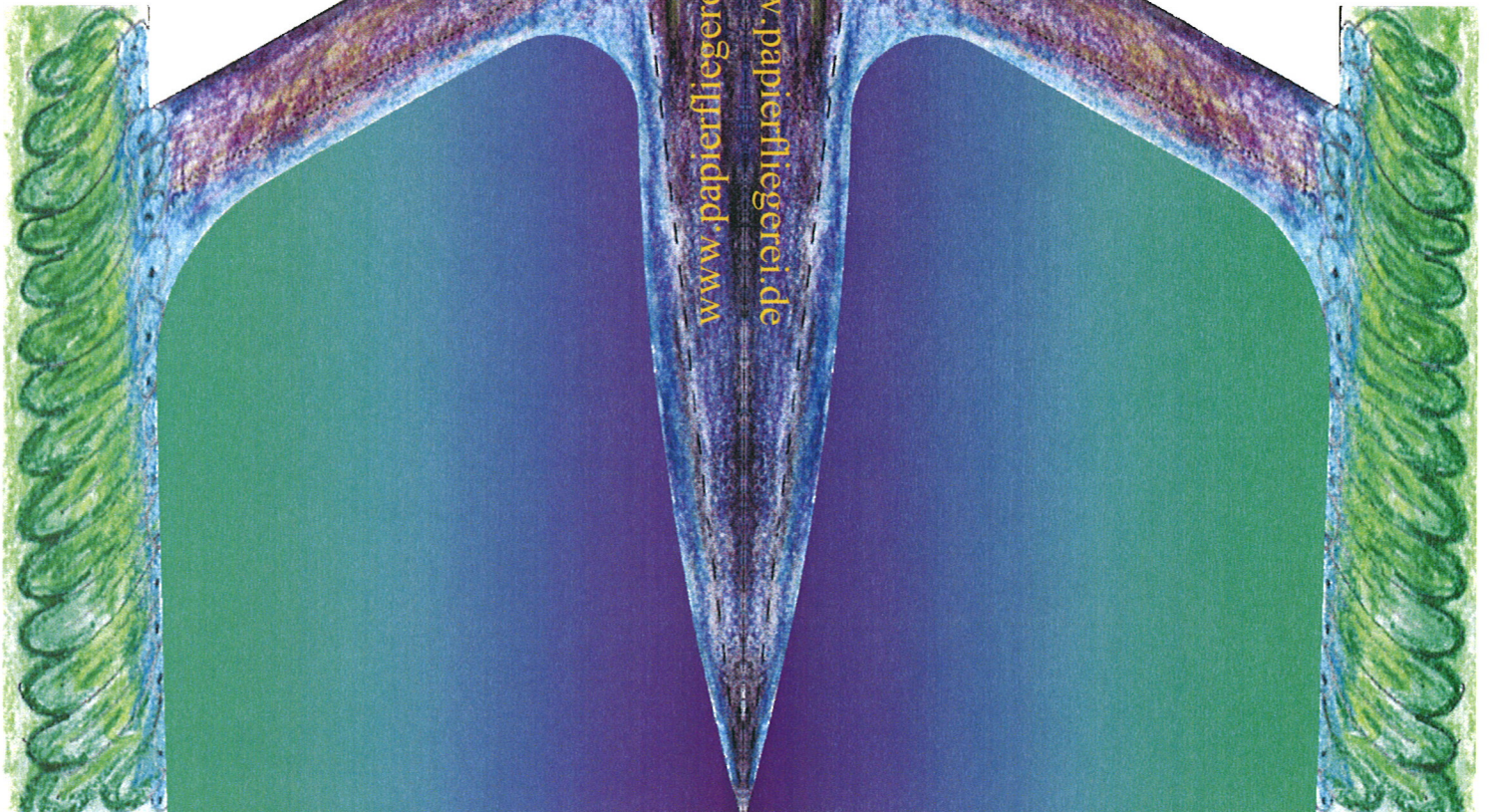
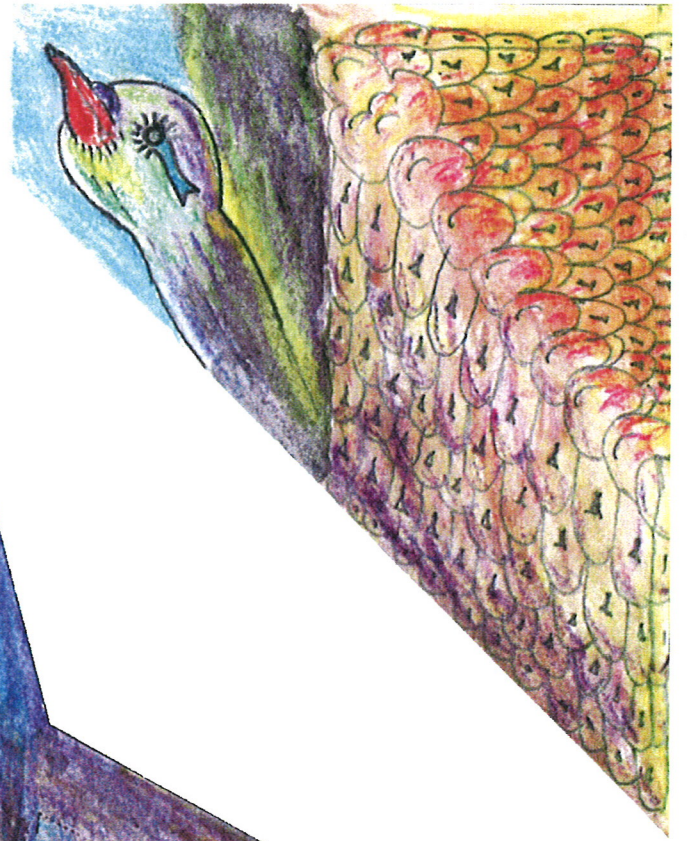
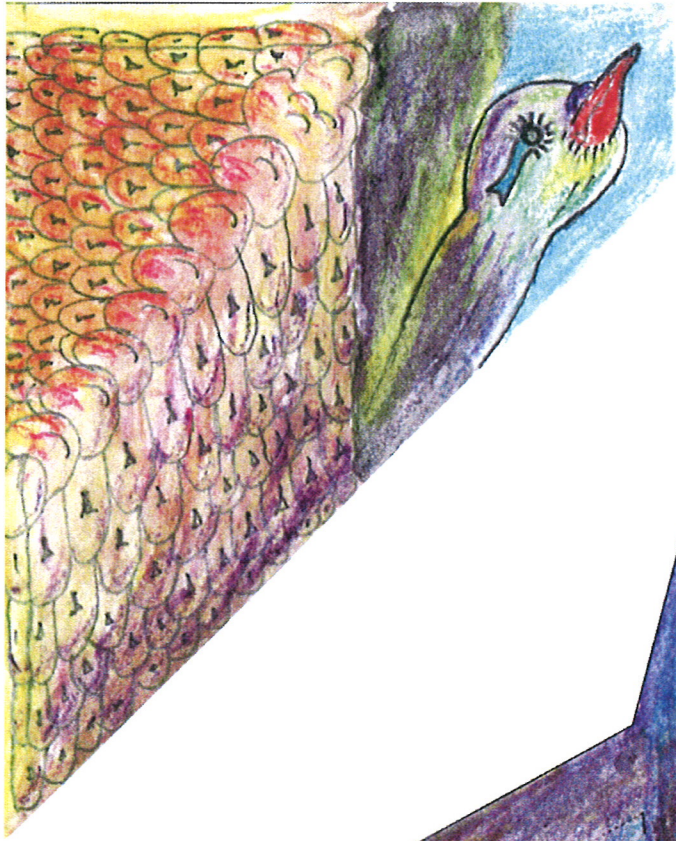

www.papierfliegerei.de

www.papierfliegerei.de